

Cable Cleats Series SI

Cable Cleats Series SI are Suitable for Fastening of single- and multi- conductor Cables Unrestricted application Indoors and Out doors



Dimension

Type	Cable Diameter		
	D	D*	D**
SI 2	36-52	33-49	30-46
SI 3	50-75	47-72	44-69

Application With Elastic Inlay



- > as padding of the cables to avoid damage of the cables under strain and / or change of surrounding temperature
- > as secure fixation of the cables and absorption of the forces due to the weight of the cables at vertical section in any height
- > as extension of the clamping range for the fixation of cables with smaller outer diameters

Fastening Example

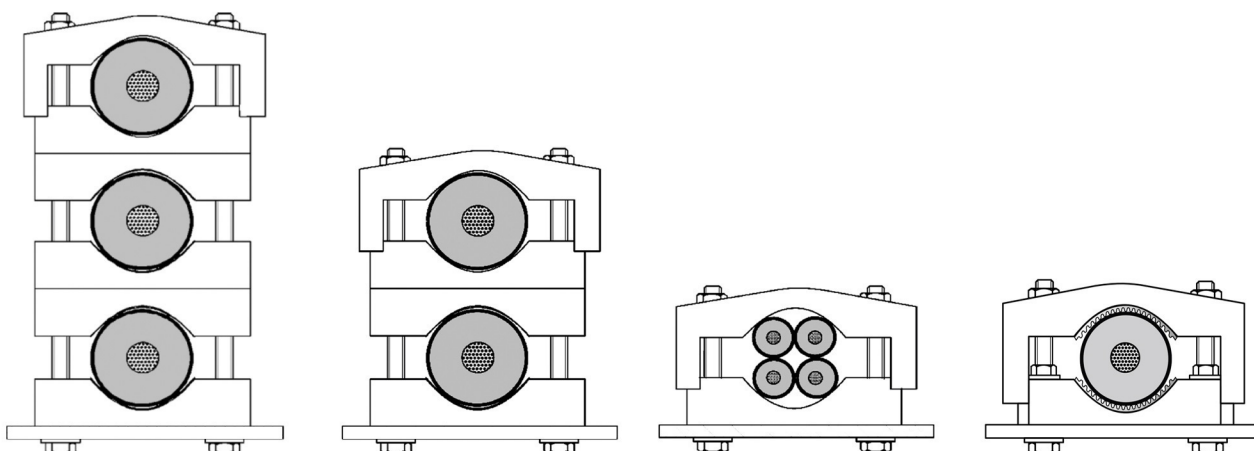

Cable Cleats Series TR are Suitable for Fastening of single- and multi-conductor Cables Unrestricted application Indoors and Out doors



Dimension

Type	Cable Diameter	
	D	D*
TR 3	29-41	26-36
TR 4	39-53	36-50
TR 5	51-64	48-61

Application With Elastic Inlay



- > as padding of the cables to avoid damage of the cables under strain and / or change of surrounding temperature
- > as secure fixation of the cables and absorption of the forces due to the weight of the cables at vertical section in any height
- > as extension of the clamping range for the fixation of cables with smaller outer diameters

Fastening Example

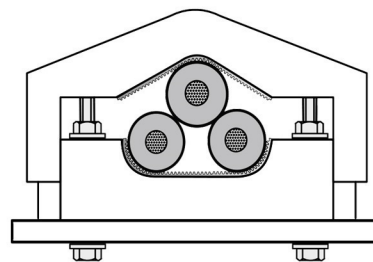
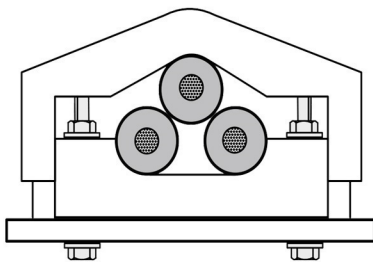

Cable Cleats Series ATR

Cable Cleats Series ATR are Suitable for Fastening of single- and multi- conductor Cables Unrestricted application Indoors and Out doors



Dimension

Type	Cable Diameter	
	D	D*
ATR3	29-41	26-38
ATR4	39-53	36-50
ATR5	51-64	48-61
ATR6	62-75	59-72

Application With Elastic Inlay



- > as padding of the cables to avoid damage of the cables under strain and / or change of surrounding temperature
- > as secure fixation of the cables and absorption of the forces due to the weight of the cables at vertical section in any height
- > as extension of the clamping range for the fixation of cables with smaller outer diameters

Fastening Example

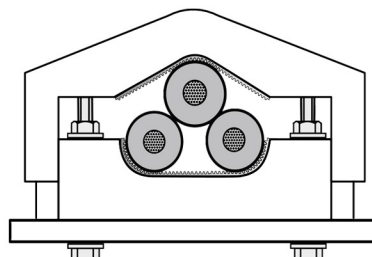
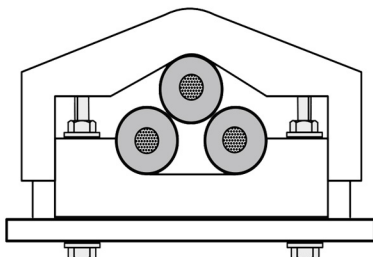

Cable Cleats Series CSI

Cable Cleats Series CSI are Suitable for Fastening of single- and multi-conductor Cables Unrestricted application Indoors and Out doors

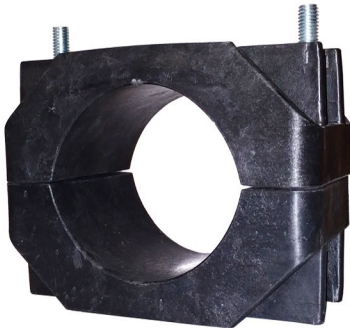

Dimension

Type	Cable Diameter		
	D	D*	D**
CSI 5	75-100	72-97	69-94
CSI 6	100-130	97-127	94-124

Application With Elastic Inlay



- > as padding of the cables to avoid damage of the cables under strain and / or change of surrounding temperature
- > as secure fixation of the cables and absorption of the forces due to the weight of the cables at vertical section in any height
- > as extension of the clamping range for the fixation of cables with smaller outer diameters

Fastening Example

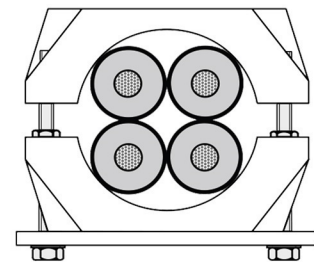
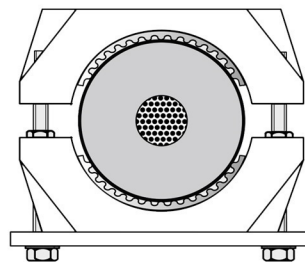
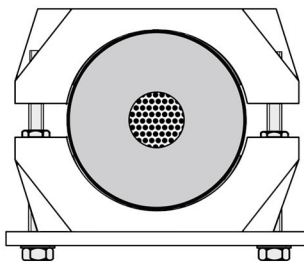

Cable Cleats Series ASI

Cable Cleats Series ASI are Suitable for Fastening of single- and multi-conductor Cables Unrestricted application Indoors and Out doors



Dimension

Type	Cable Diameter		
	D	D*	D**
ASI2	36-52	33-49	30-46
ASI3	50-75	47-72	44-69
ASI4	66-90	63-87	60-84
ASI5	75-100	72-97	69-94
ASI6	100-130	97-127	94-124

Application With Elastic Inlay



- > as padding of the cables to avoid damage of the cables under strain and / or change of surrounding temperature
- > as secure fixation of the cables and absorption of the forces due to the weight of the cables at vertical section in any height
- > as extension of the clamping range for the fixation of cables with smaller outer diameters

Fastening Example

